

8. Level 3 Repair

8-1. Components Layout

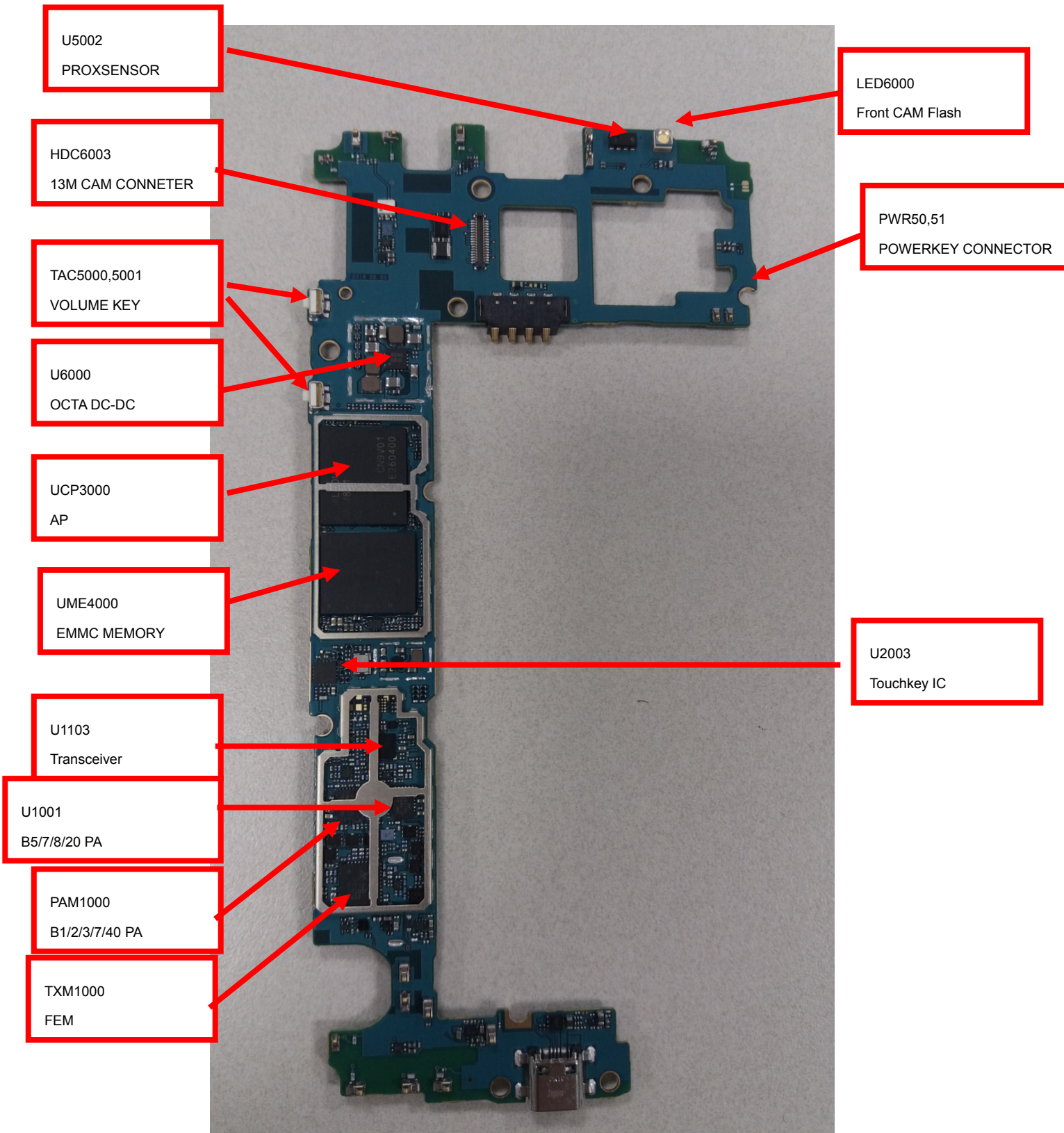

8. Level 3 Repair

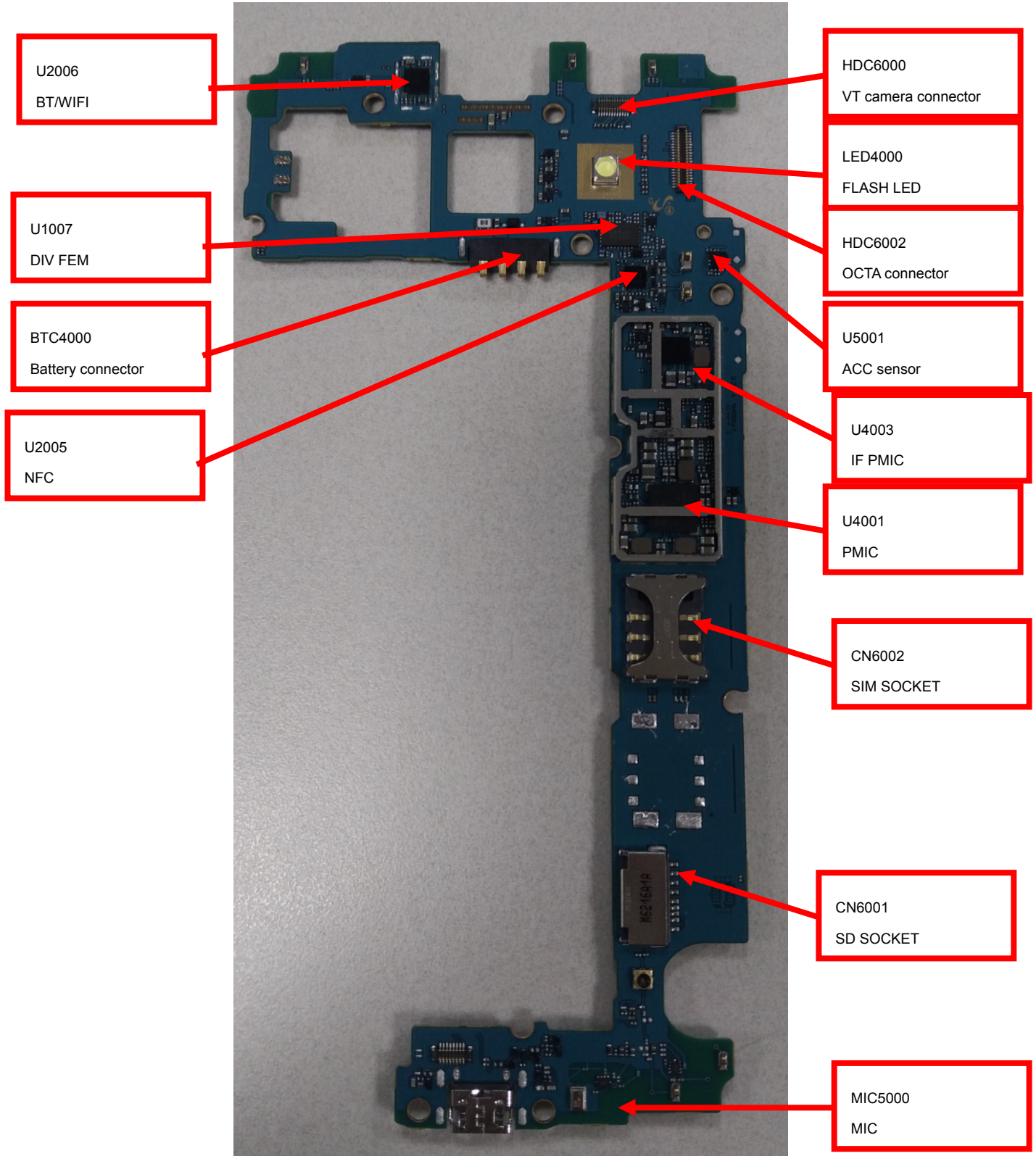

8. Level 3 Repair

8-2. Block Diagram

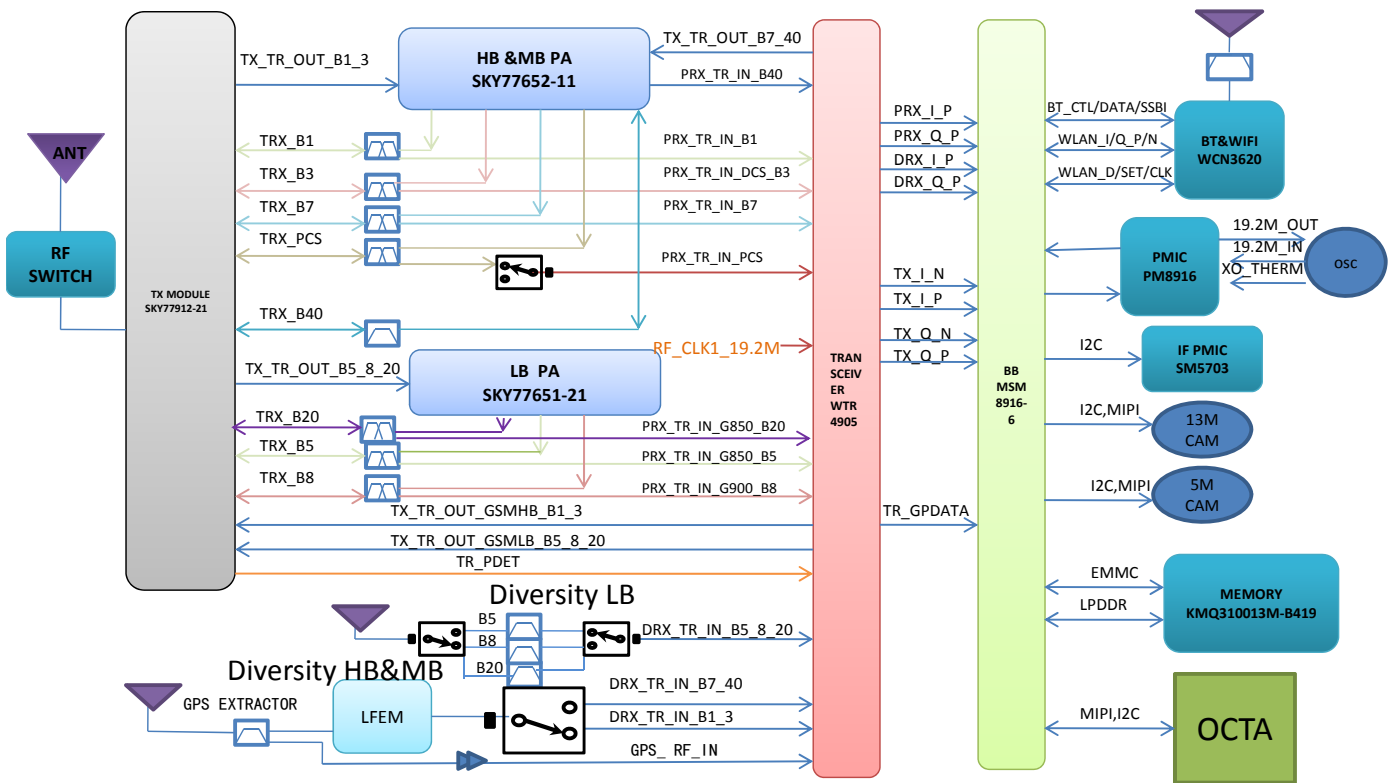

8. Level 3 Repair

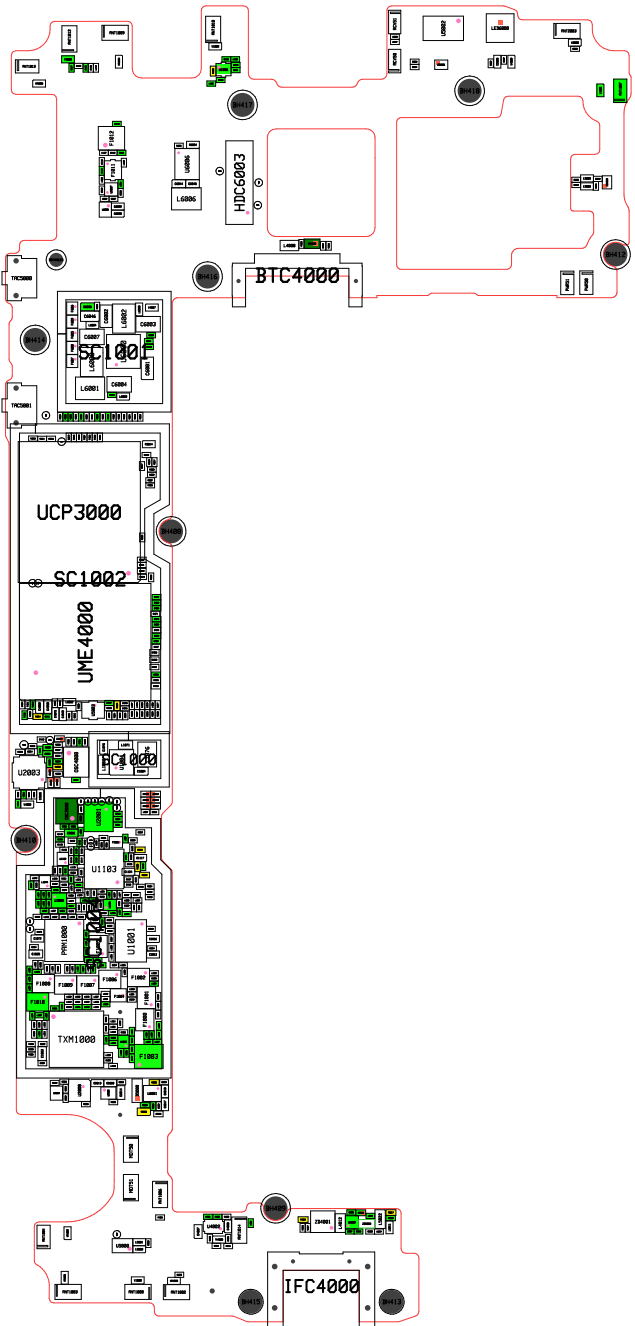

Confidential and proprietary-the contents in this service guide subject to change without prior notice





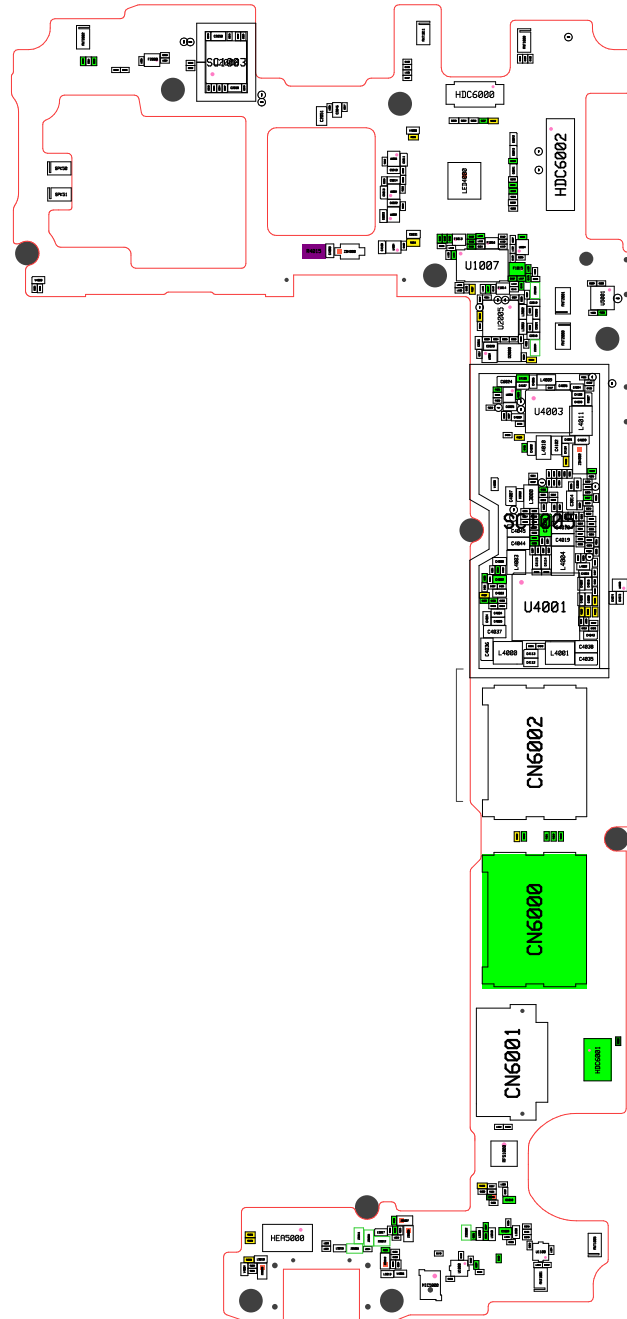

Distribution, transmission, or infringement of any content or data from this document without Samsung's written authorization is strictly prohibited.

8. Level 3 Repair

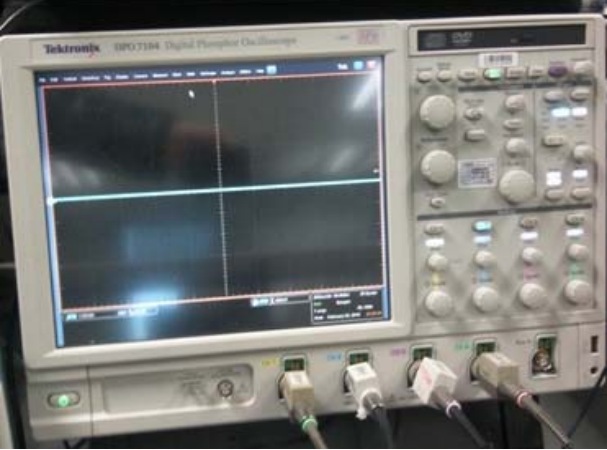

8. Level 3 Repair

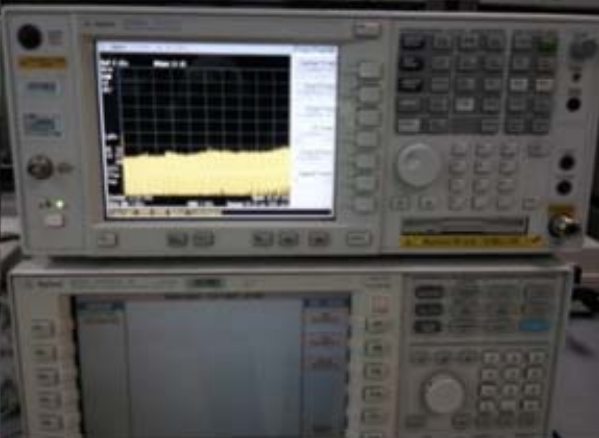
8-3. Flow Chart of Troubleshooting

| | |
|---|--|
|  |  |
| Oscilloscope | Digital Multimeter |
|  |  |
| Power Supply | + driver, ESD Safe Tweezer |
|  |  |
| 8960 & Spectrum Analyzer | Soldering iron |

8. Level 3 Repair

8-4-1. Power On

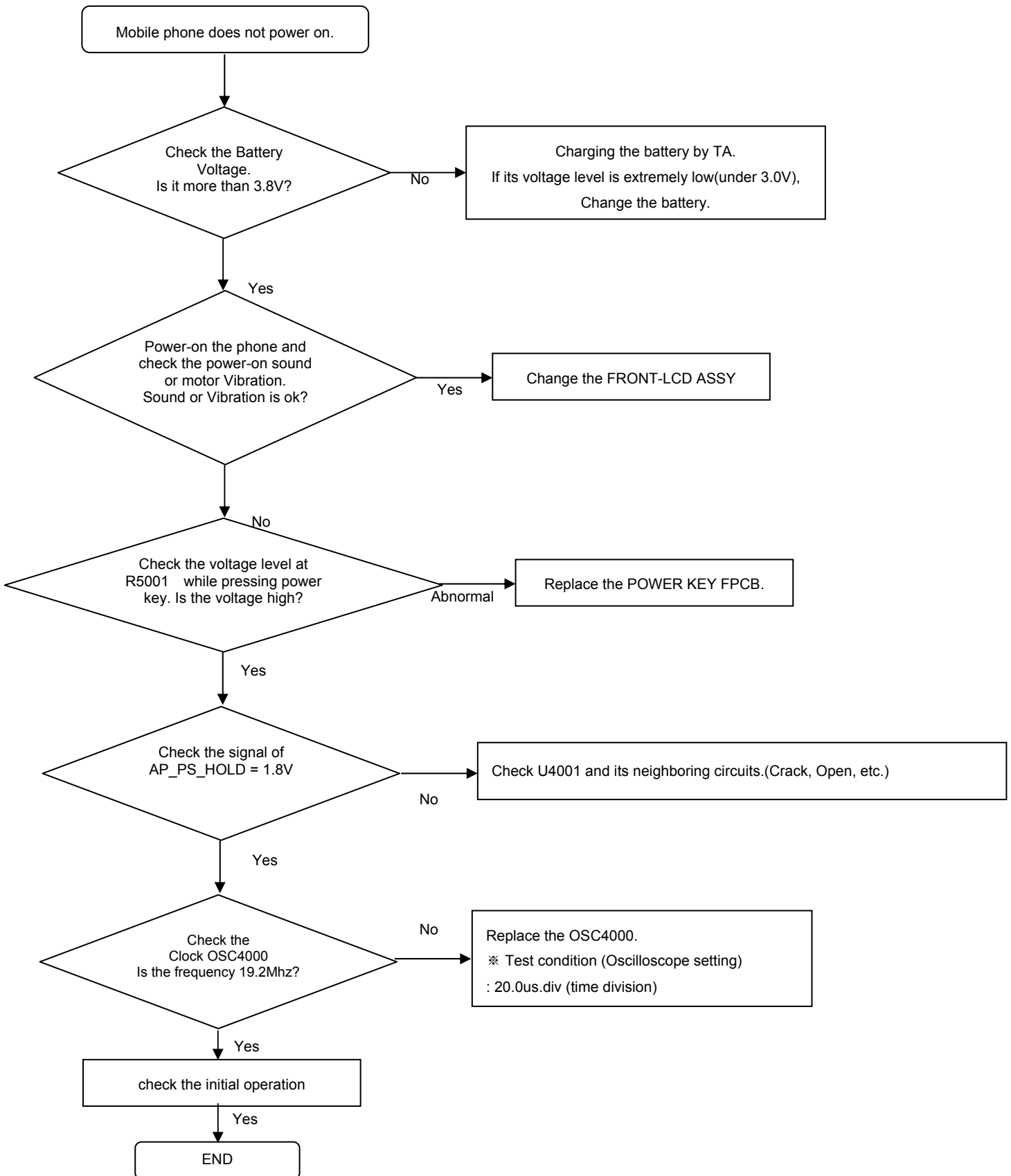

8. Level 3 Repair

8-4-2. Initial

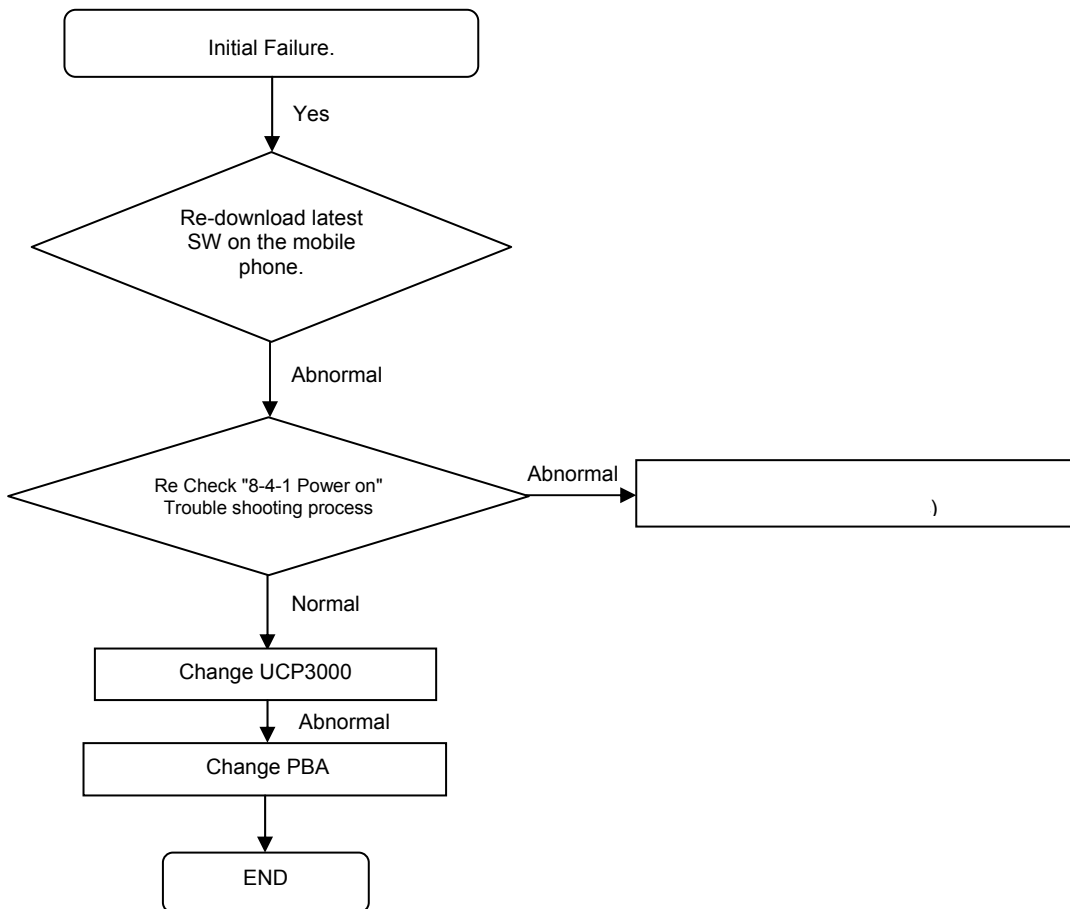

8. Level 3 Repair

8-4-3. No Service

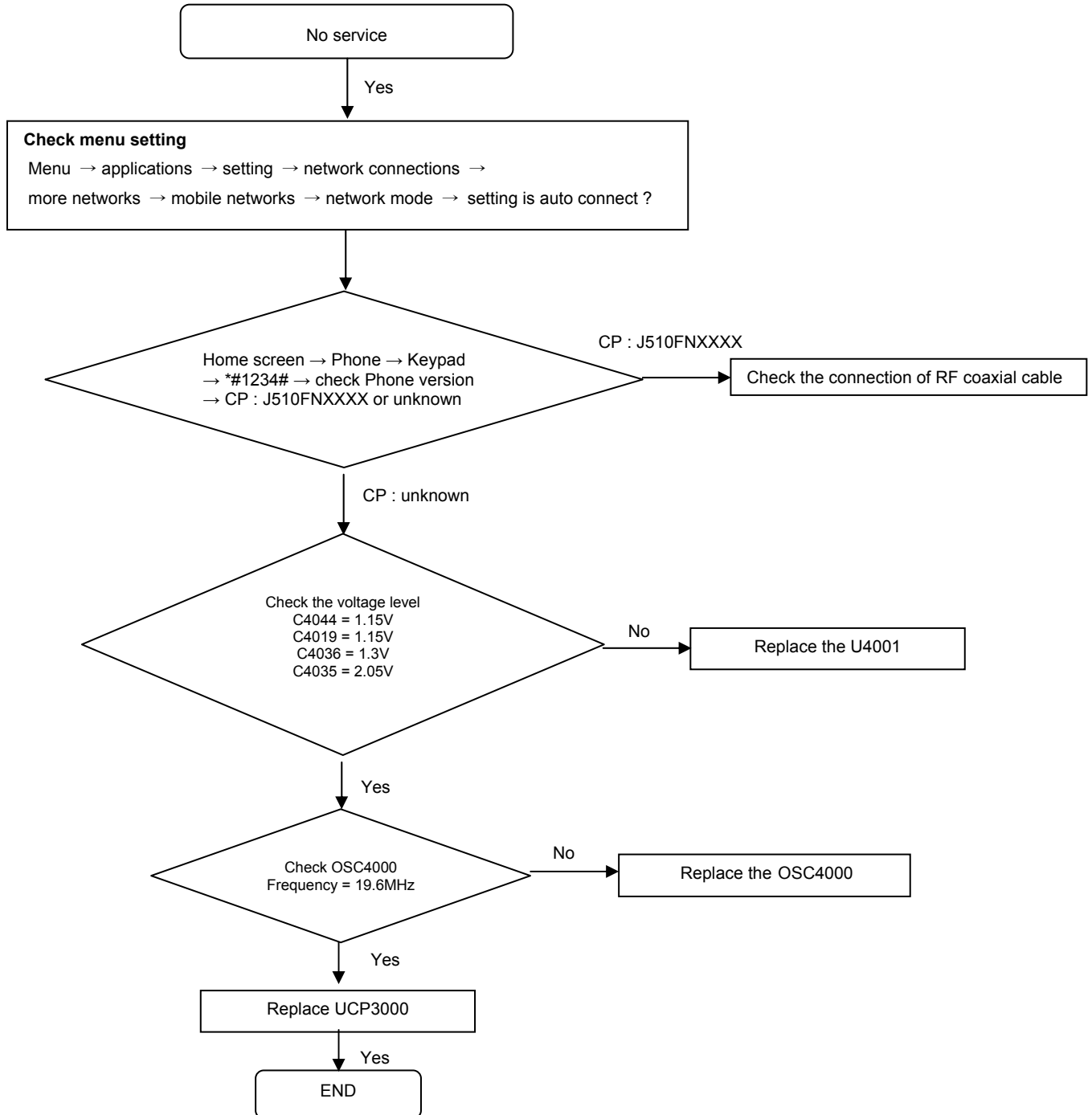

8. Level 3 Repair

8-4-4. SIM Part

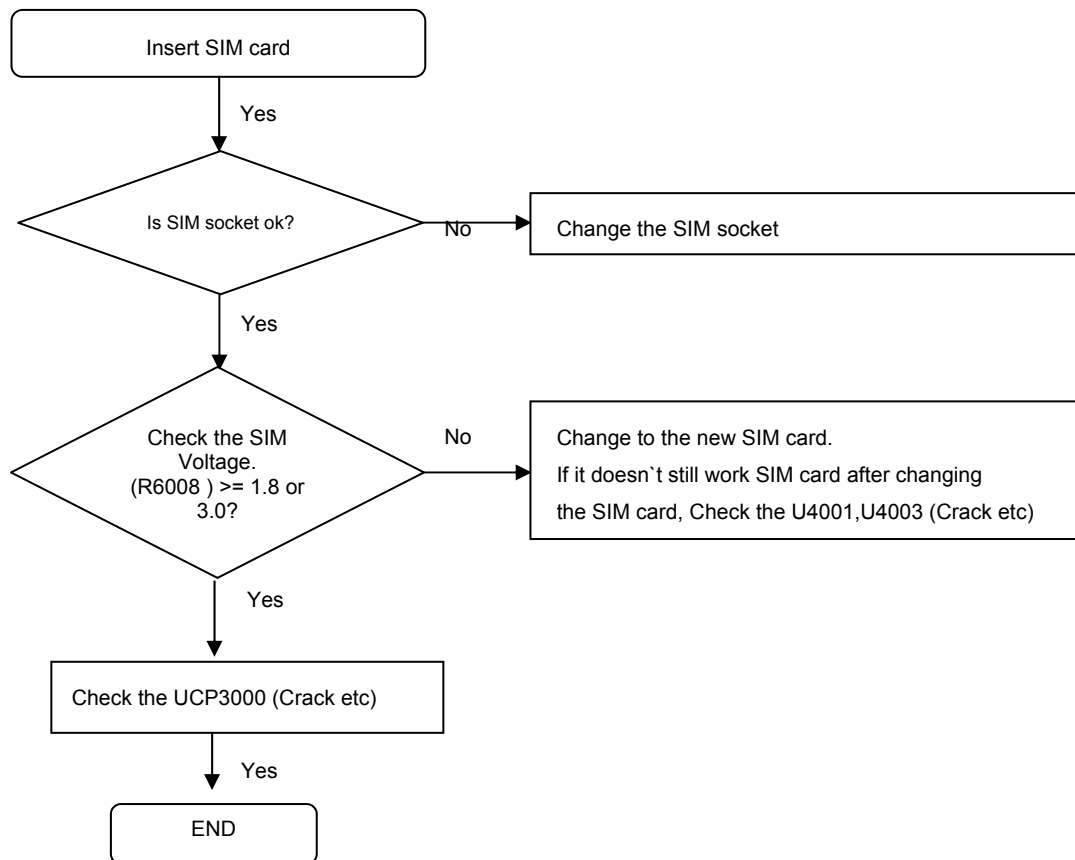

8. Level 3 Repair

8-4-5. LCD Part

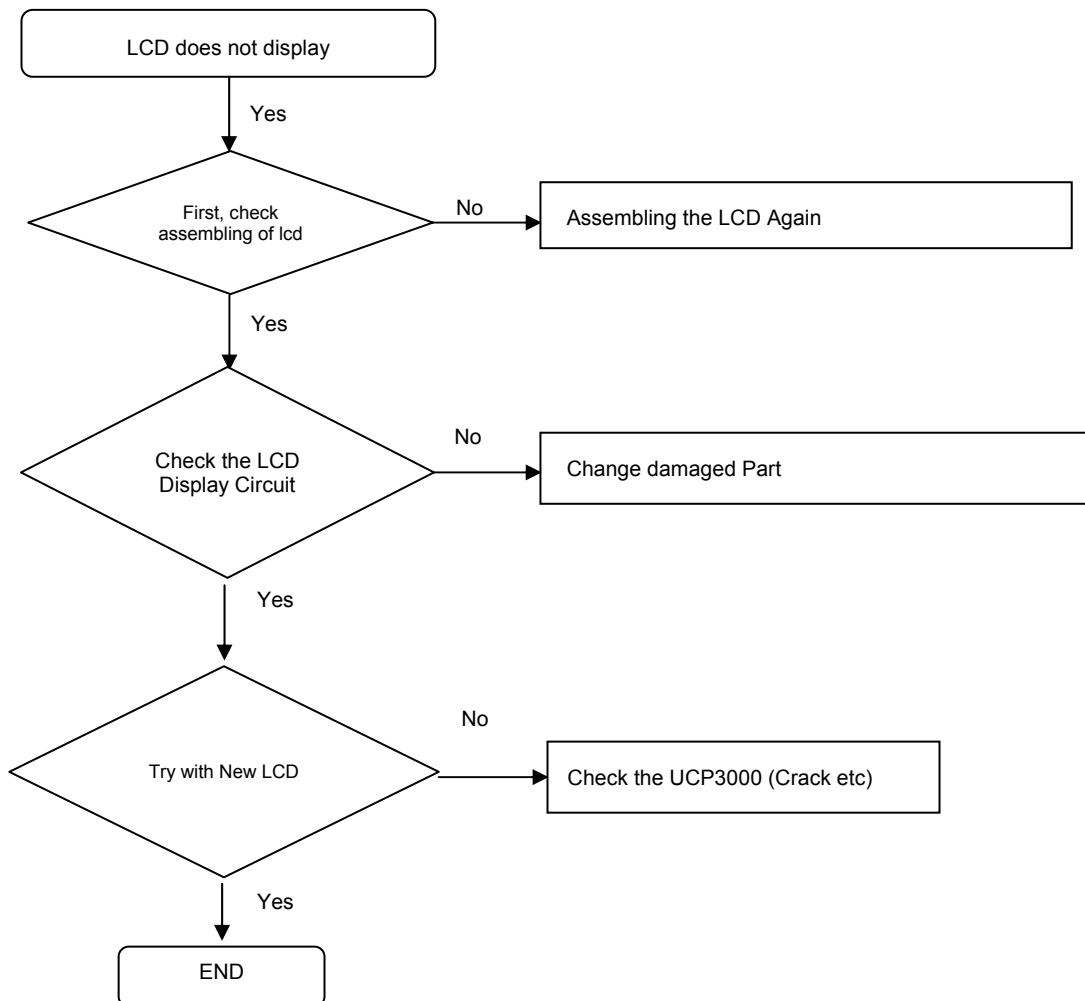

8. Level 3 Repair

8-4-6. SPK Part

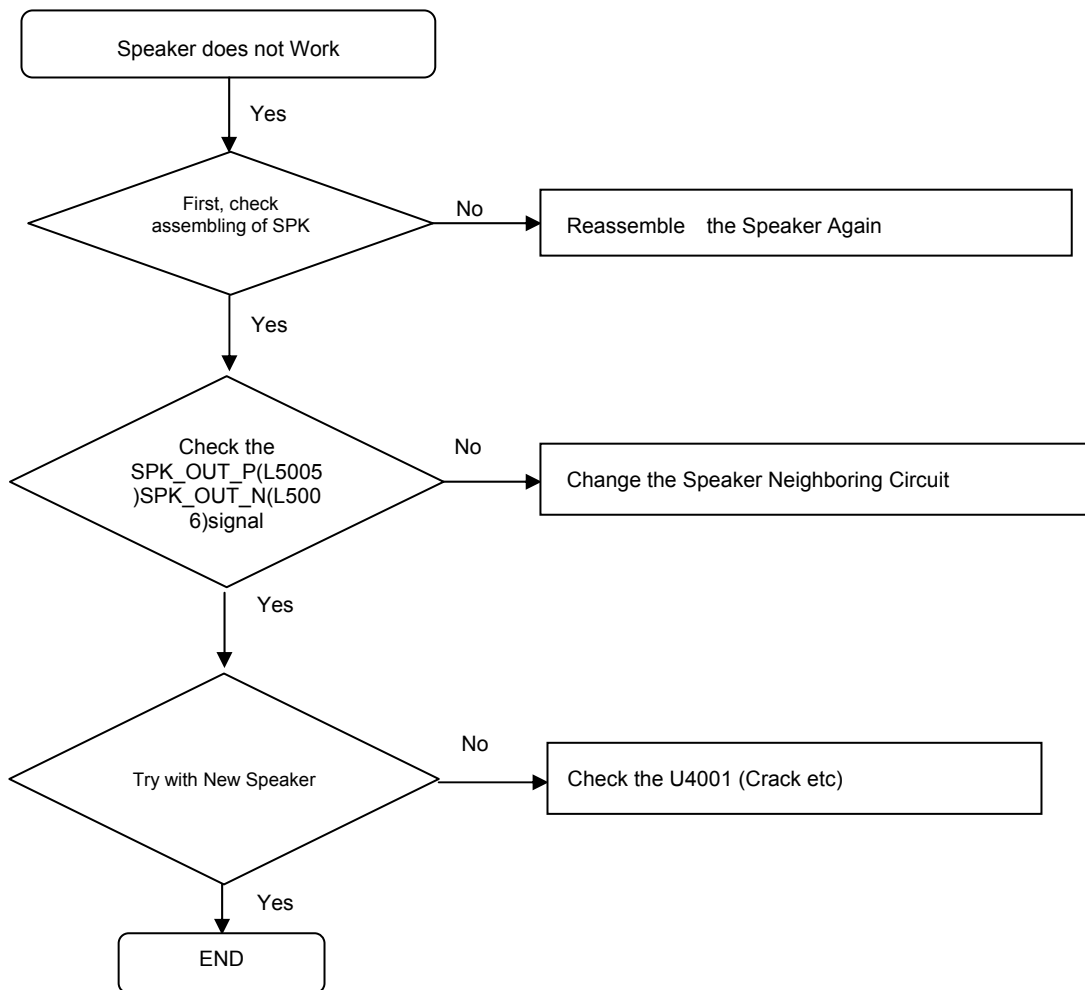

8. Level 3 Repair

8-4-7 MIC

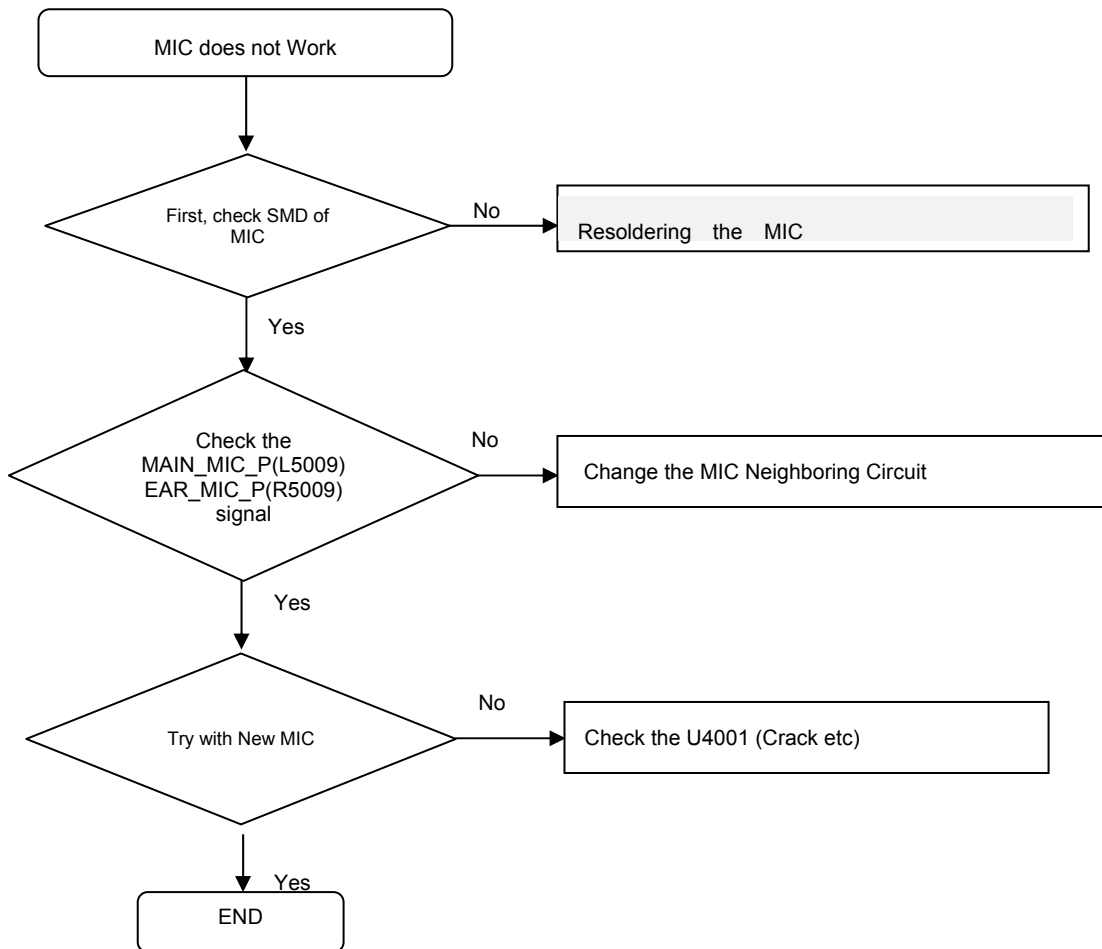

8. Level 3 Repair

8-4-8. RCV

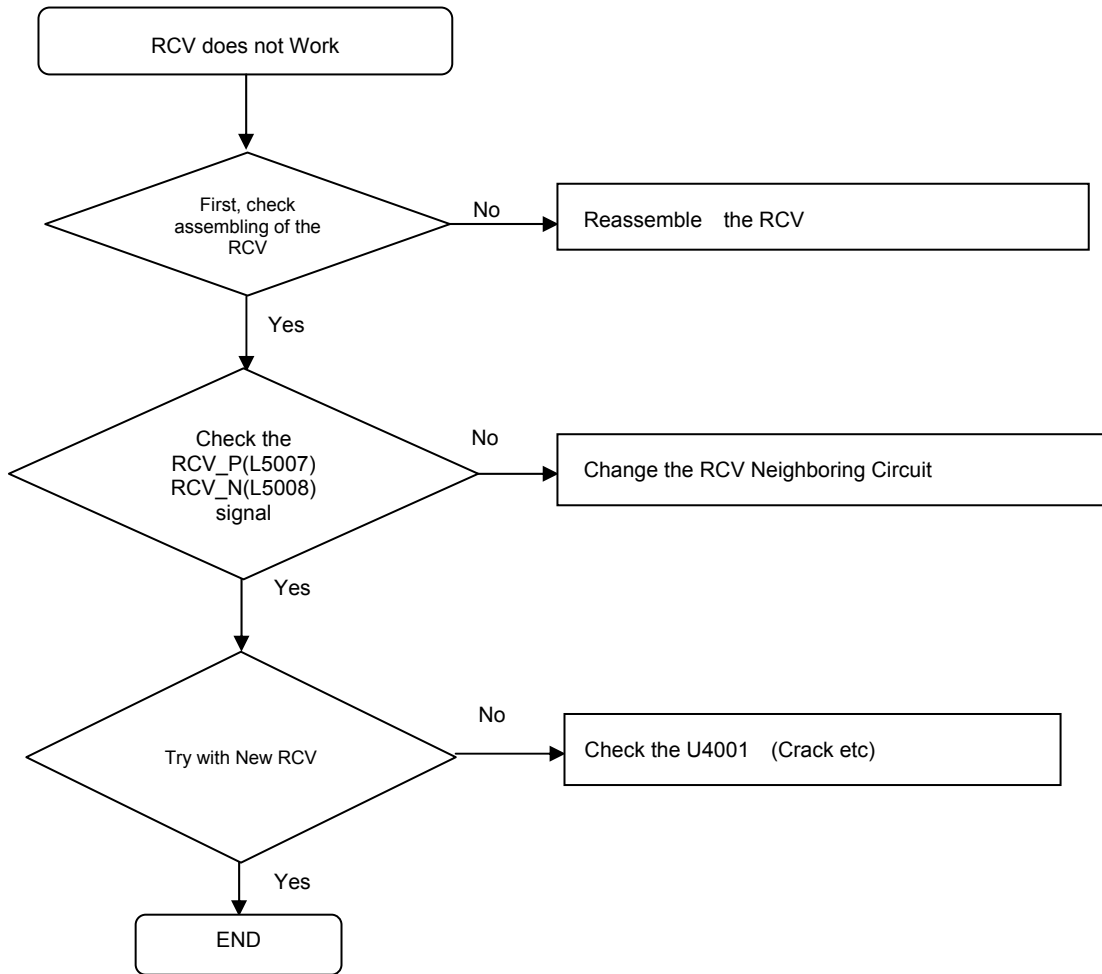

8. Level 3 Repair

8-4-9. Key Input

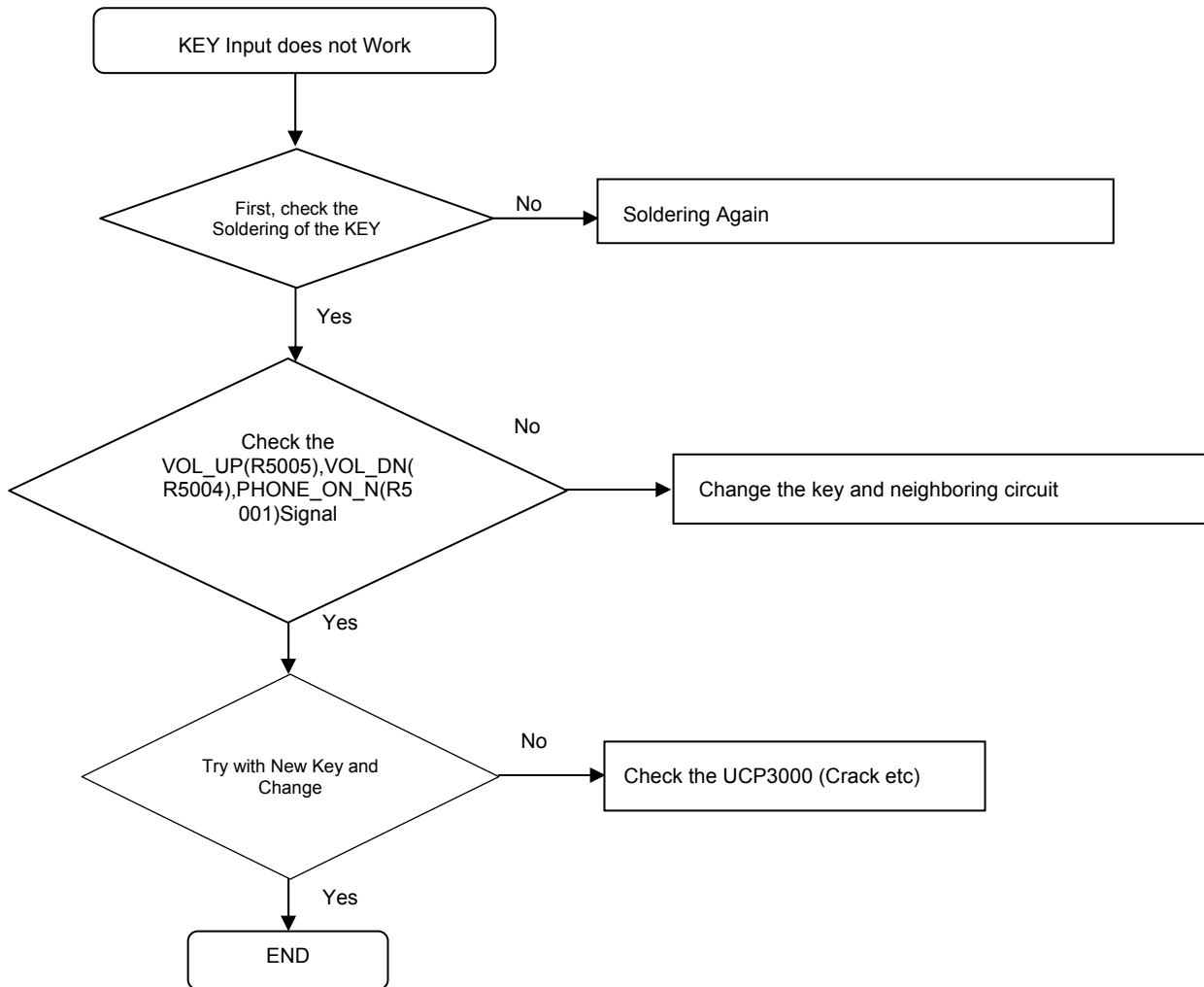

8. Level 3 Repair

8-4-10. Vibration Motor

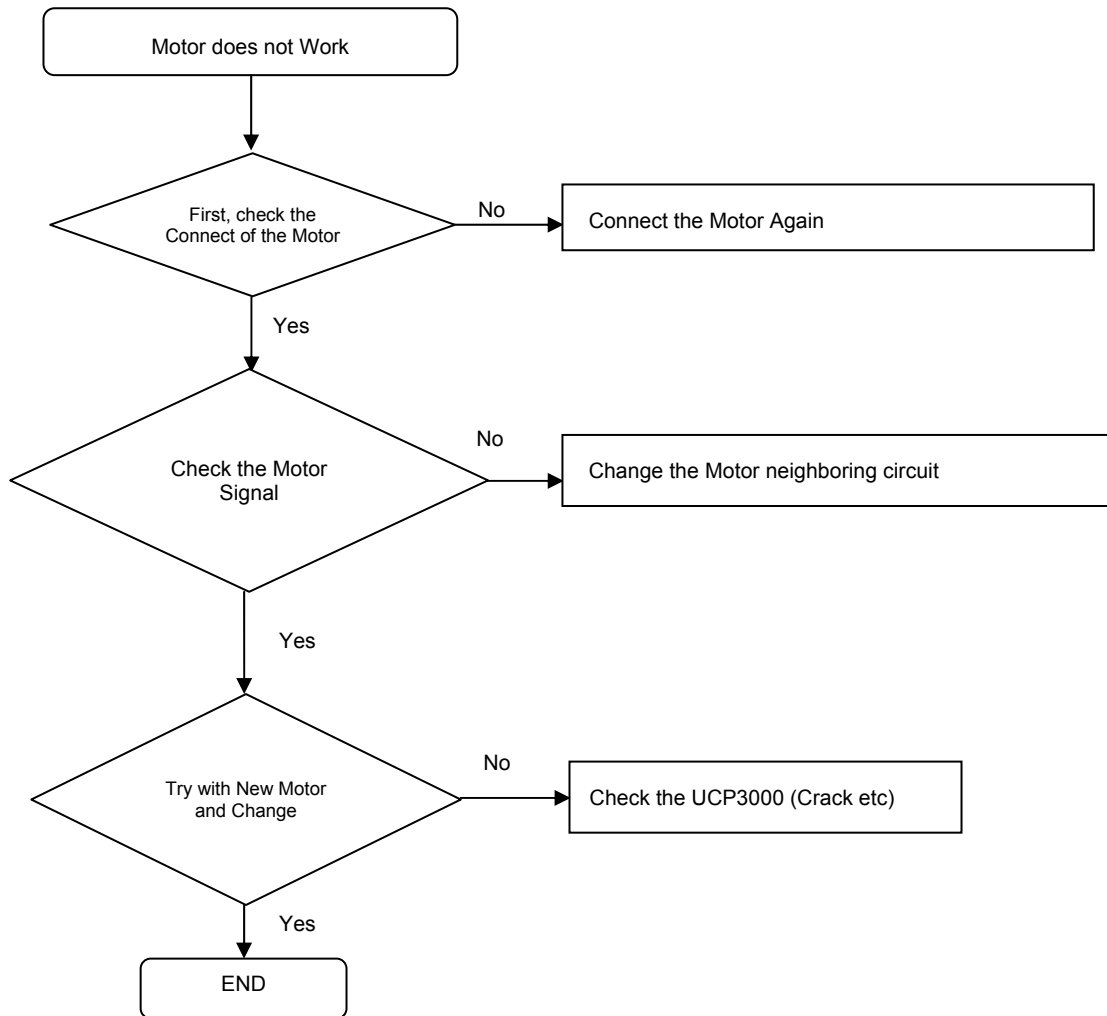

8. Level 3 Repair

8-4-11.Main CAMERA

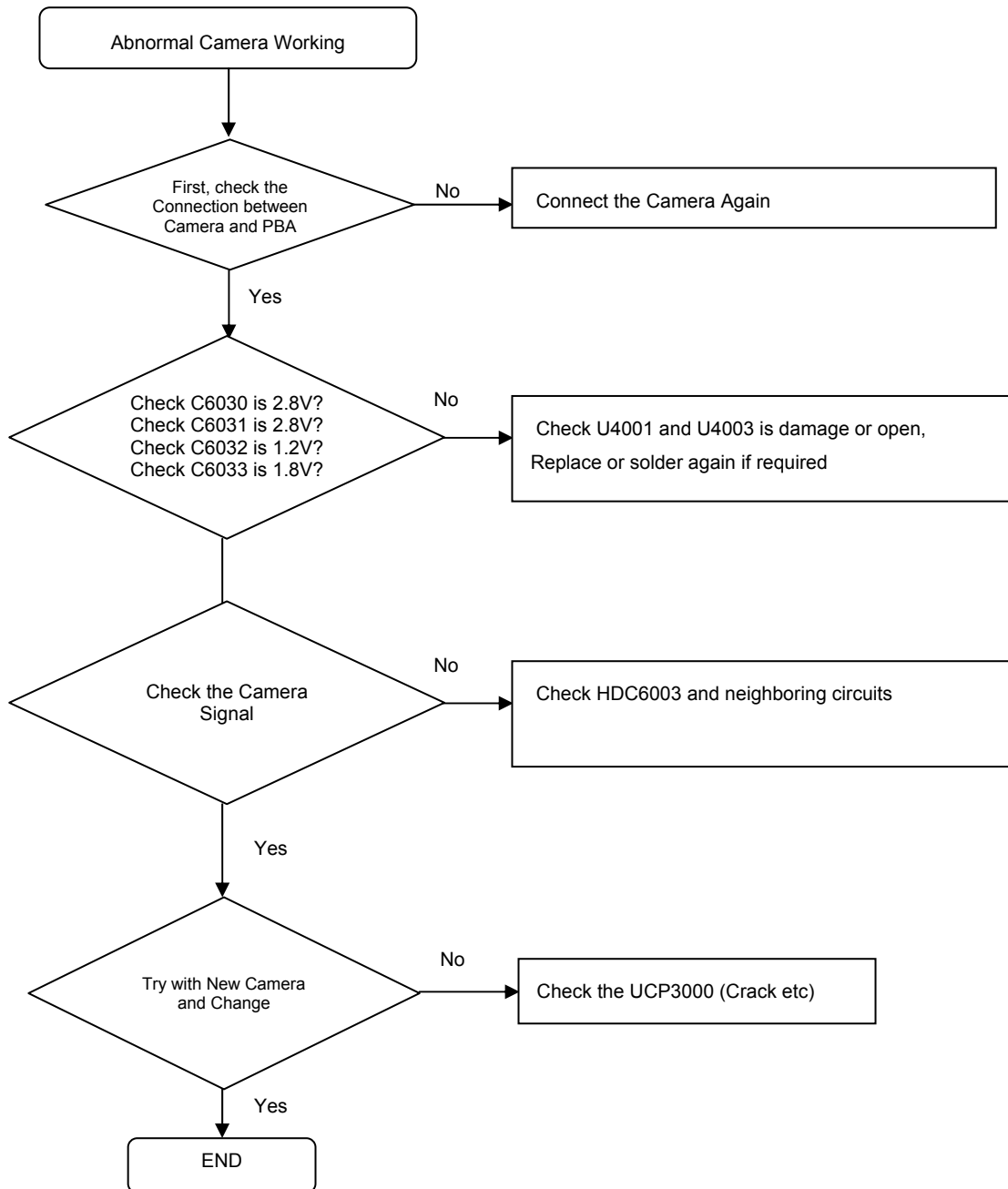

8. Level 3 Repair

8-4-12.SUB CAMERA

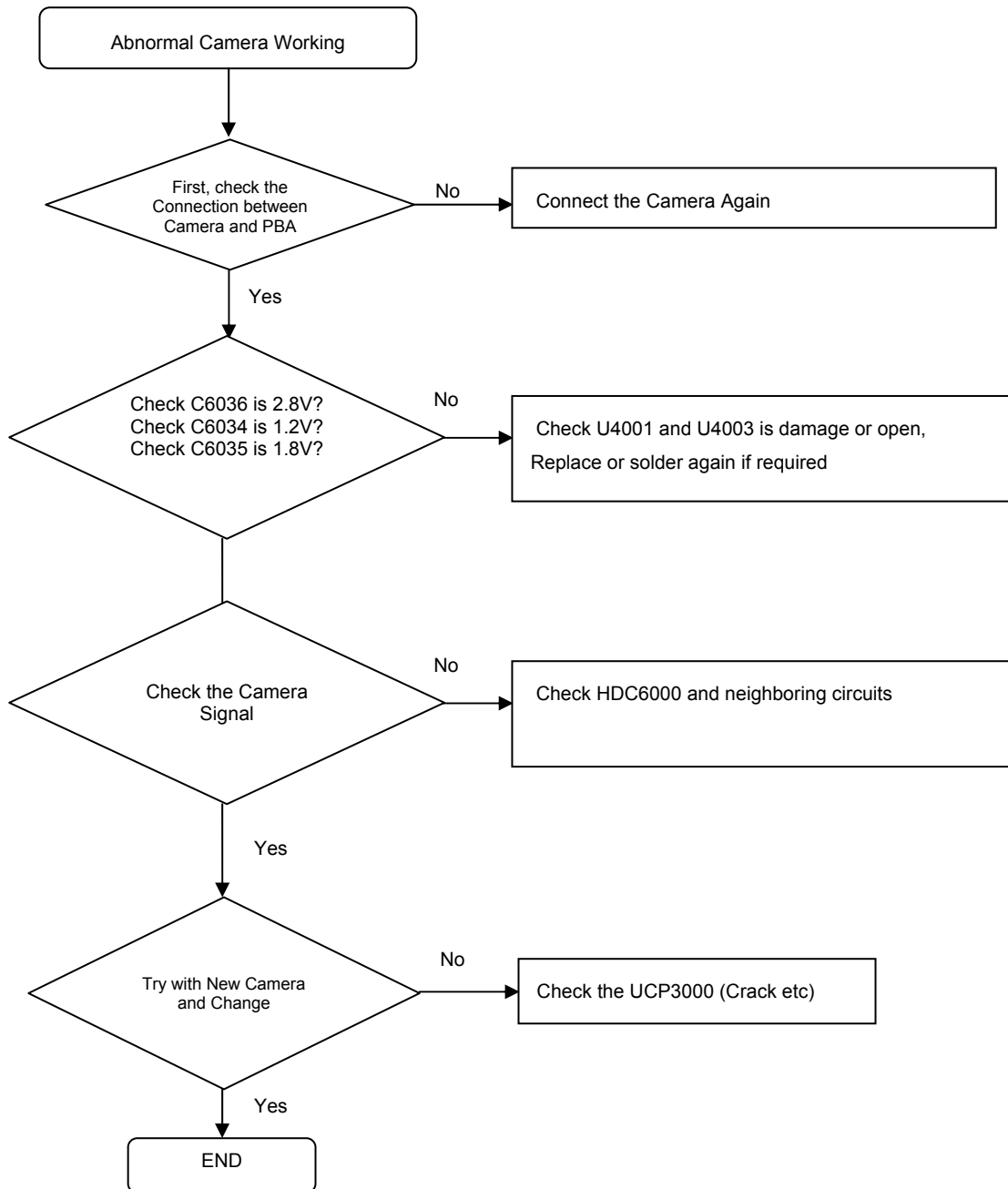

8. Level 3 Repair

8-4-13. Touch Screen

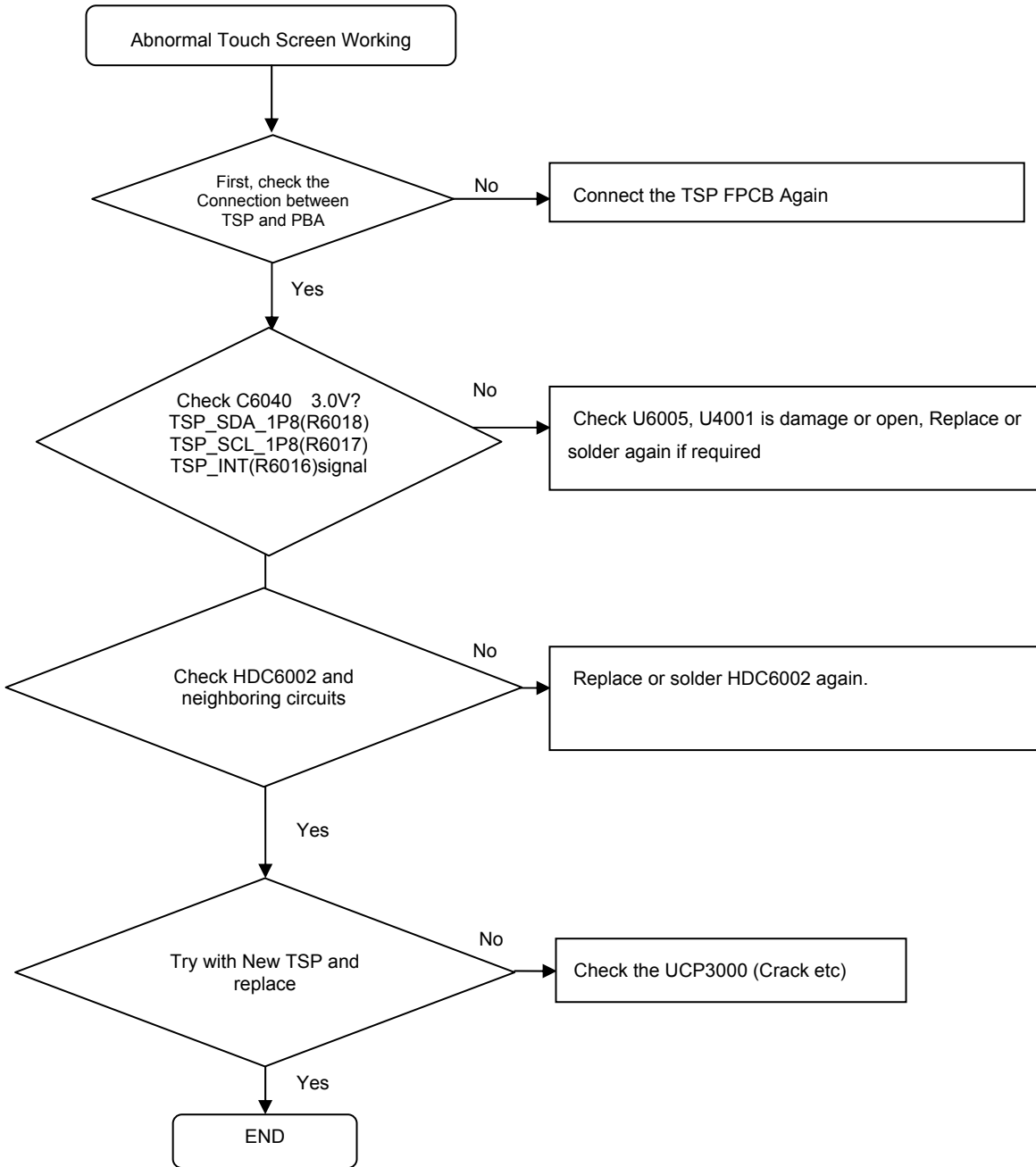

8. Level 3 Repair

8-4-14. Sensor

8-4-14-1. Proxi Sensor

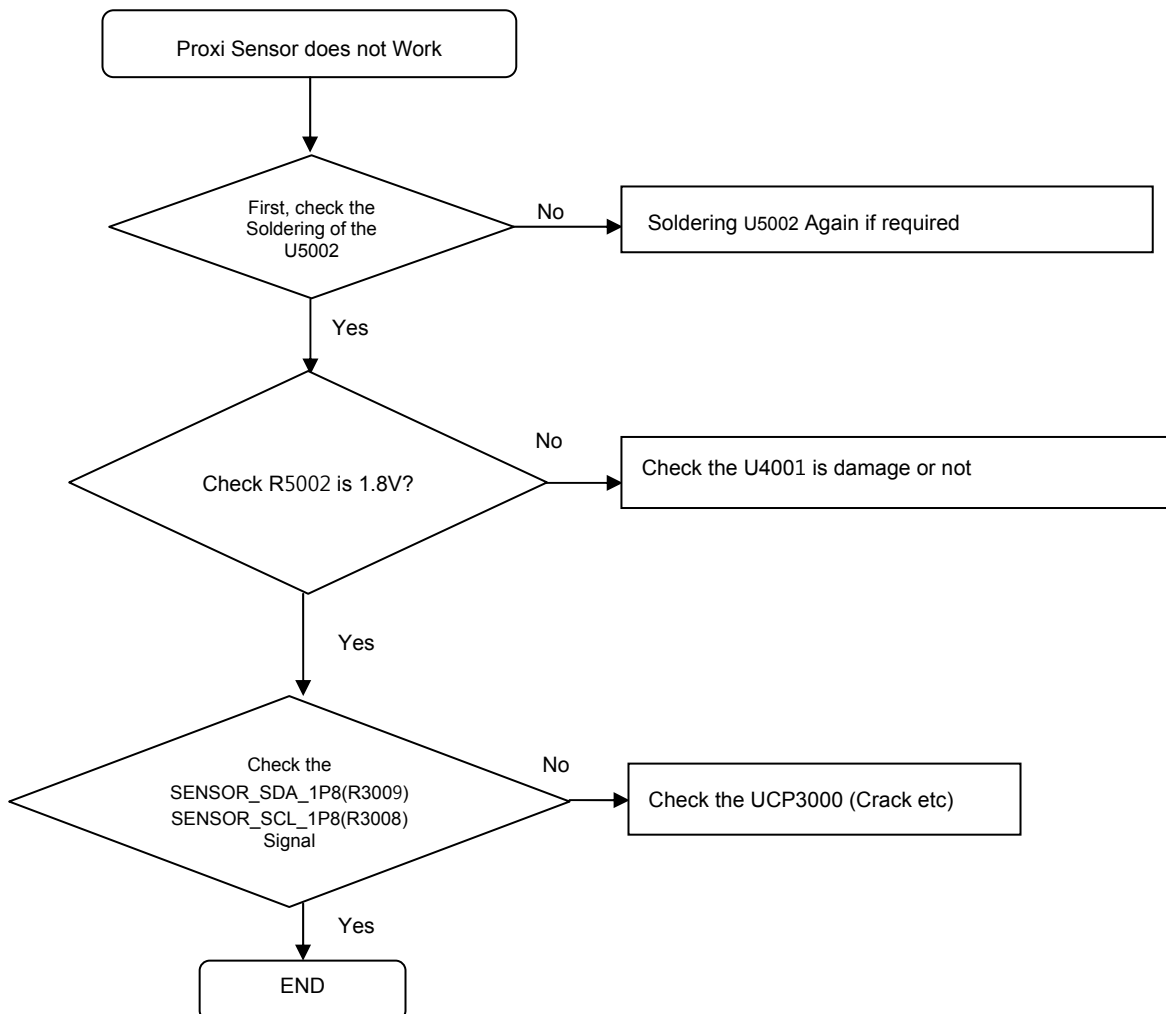

8. Level 3 Repair

8-4-14-2. Accel Sensor

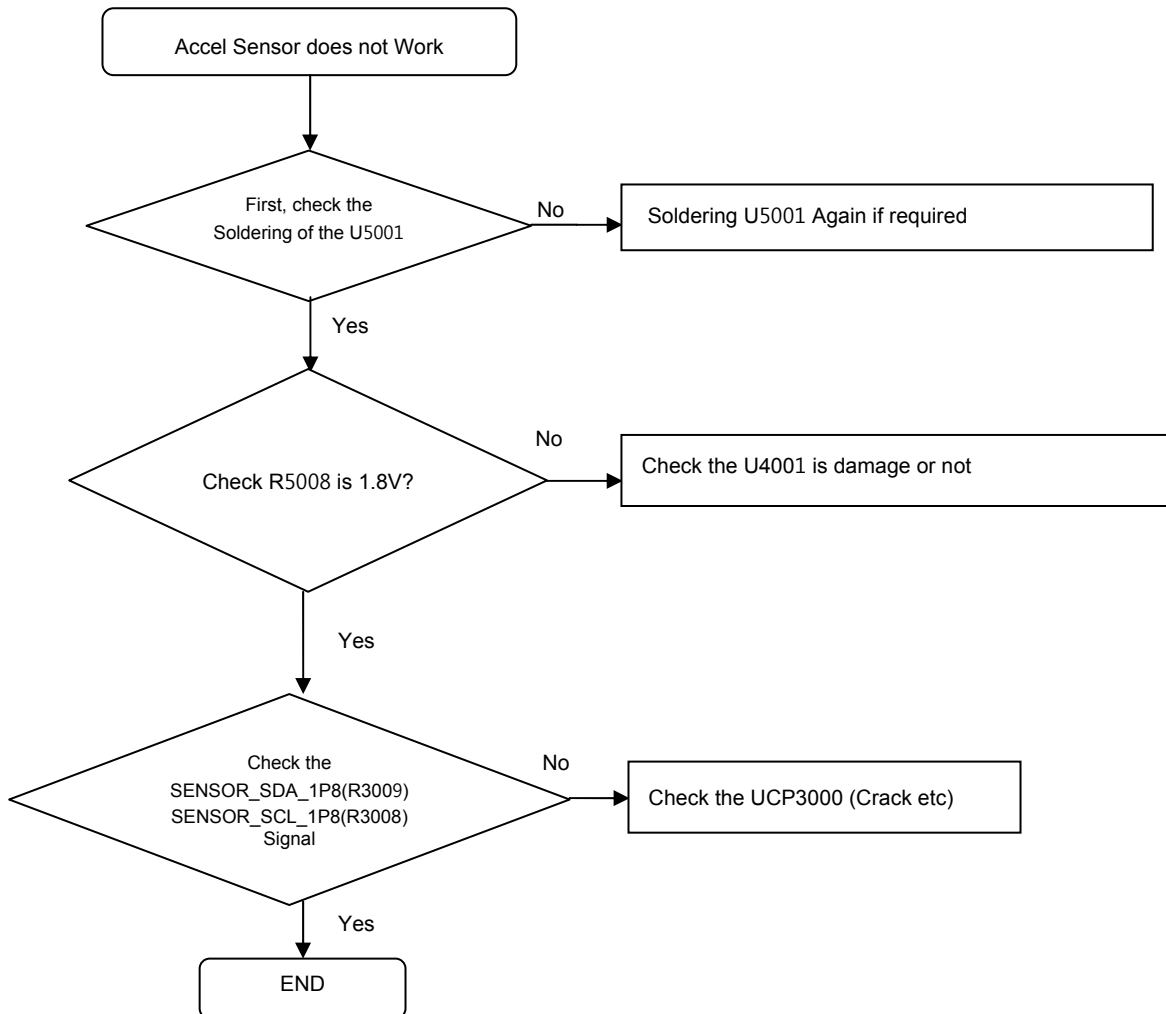

8. Level 3 Repair

8-4-15. GSM 850,900,1800,1900 WCDMA 1,2,5,8 / LTE FDD BAND 1,3,5,7,8,20 / LTE TDD BAND 40 RX

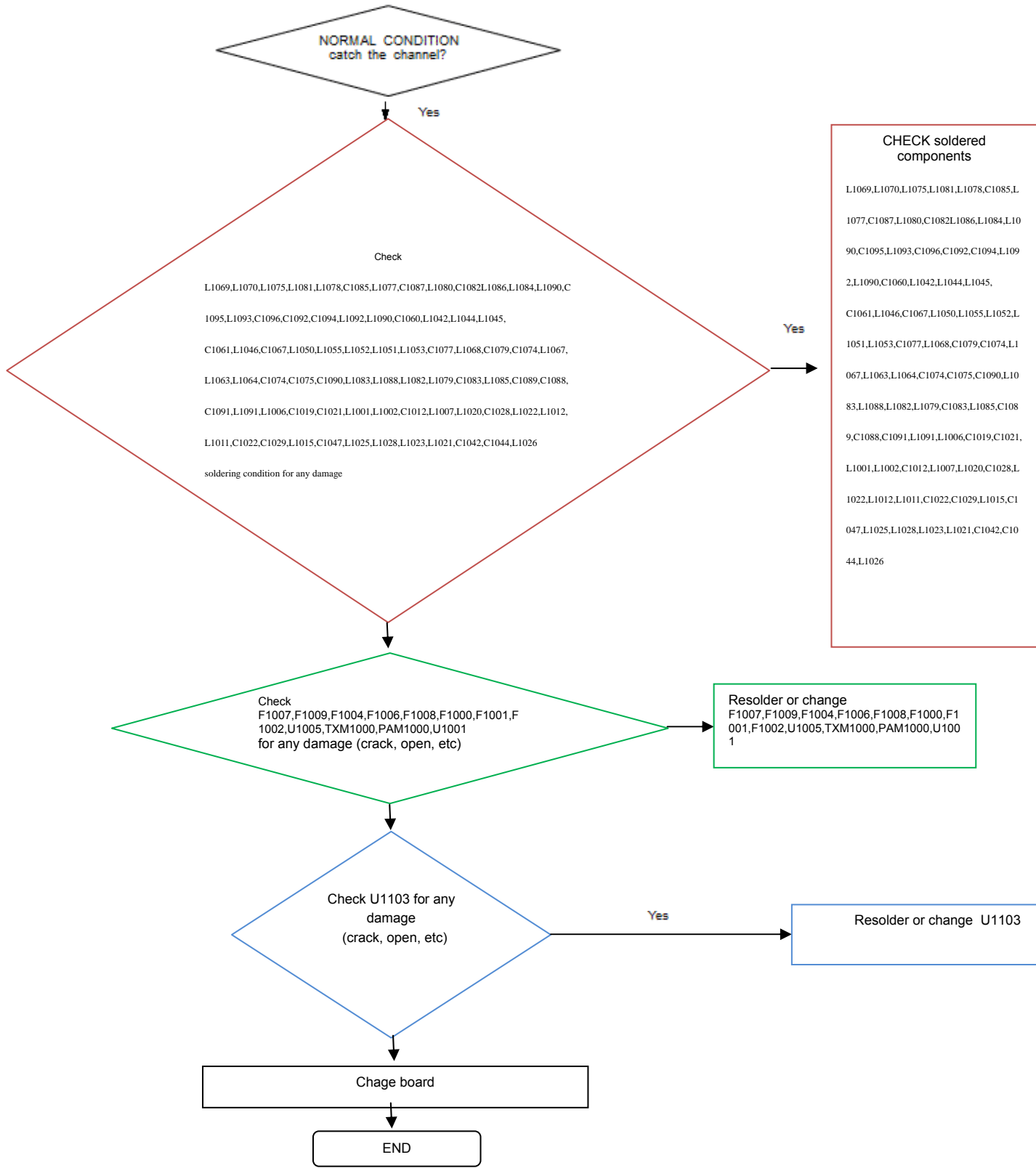

8. Level 3 Repair

8-4-16. GSM 850,900,1800,1900 WCDMA 1,2,5,8 / LTE FDD BAND 1,3,5,7,8,20 / LTE TDD BAND 40 TX

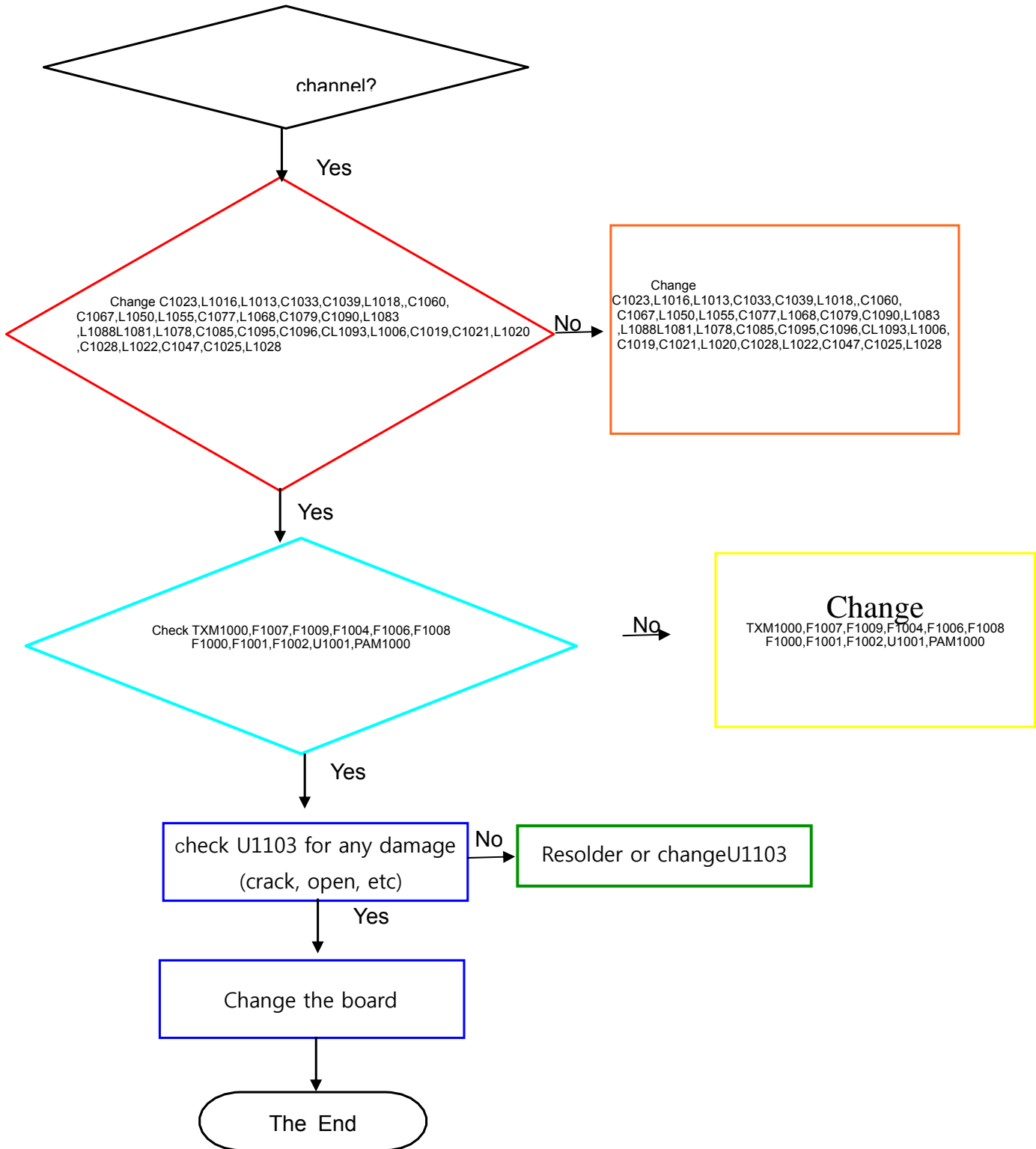

8. Level 3 Repair

8-4-17. RF Section(WLAN / BT/FM)

- WLAN RX

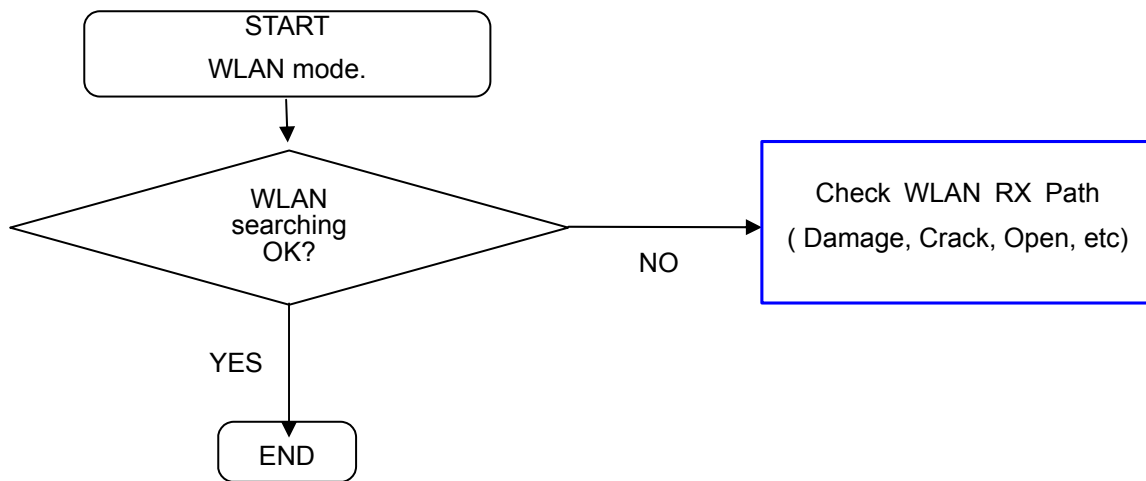

8. Level 3 Repair

- WLAN TX

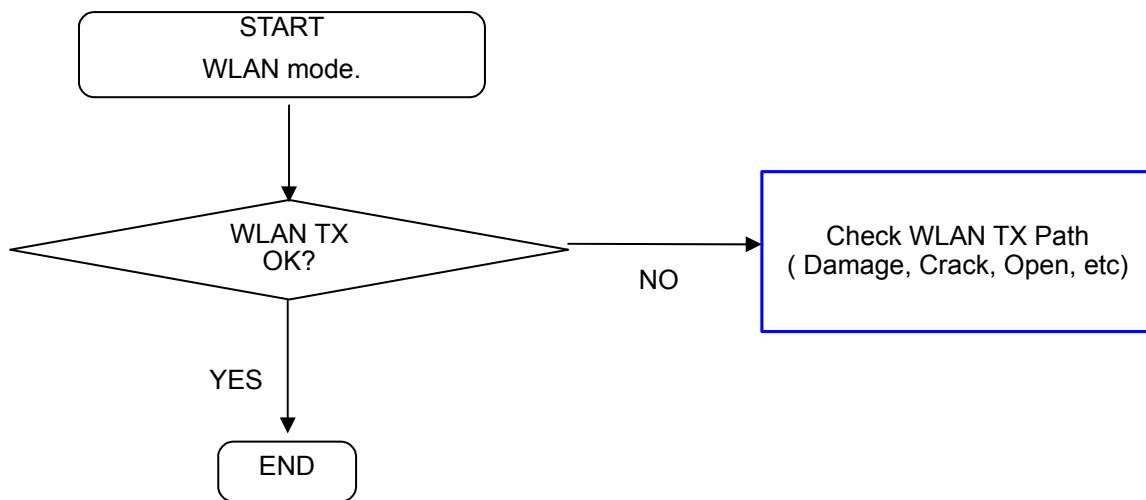

8. Level 3 Repair

- BT

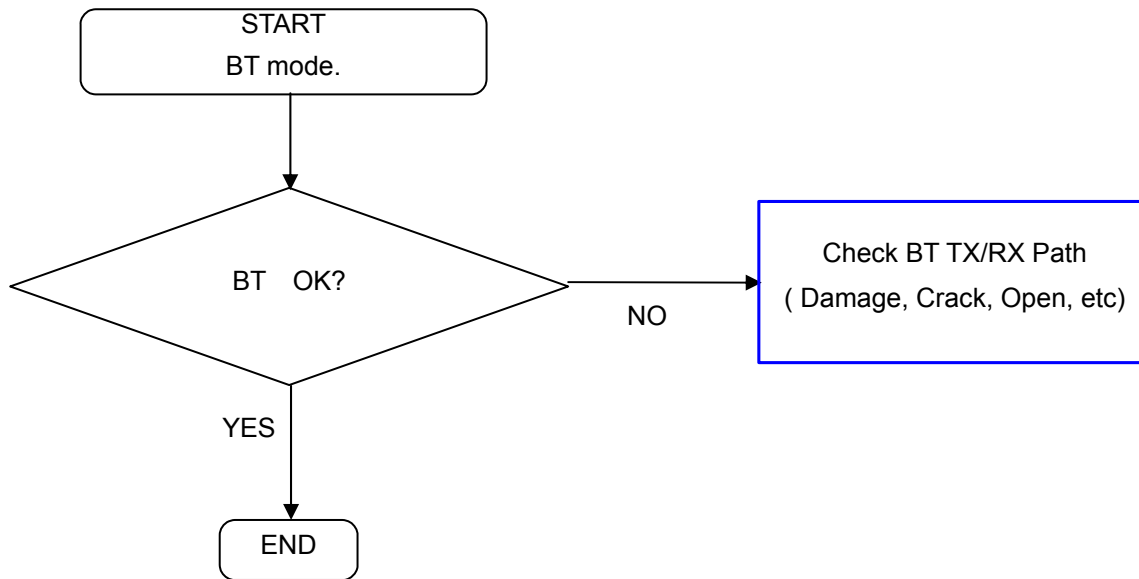

8. Level 3 Repair

- FM

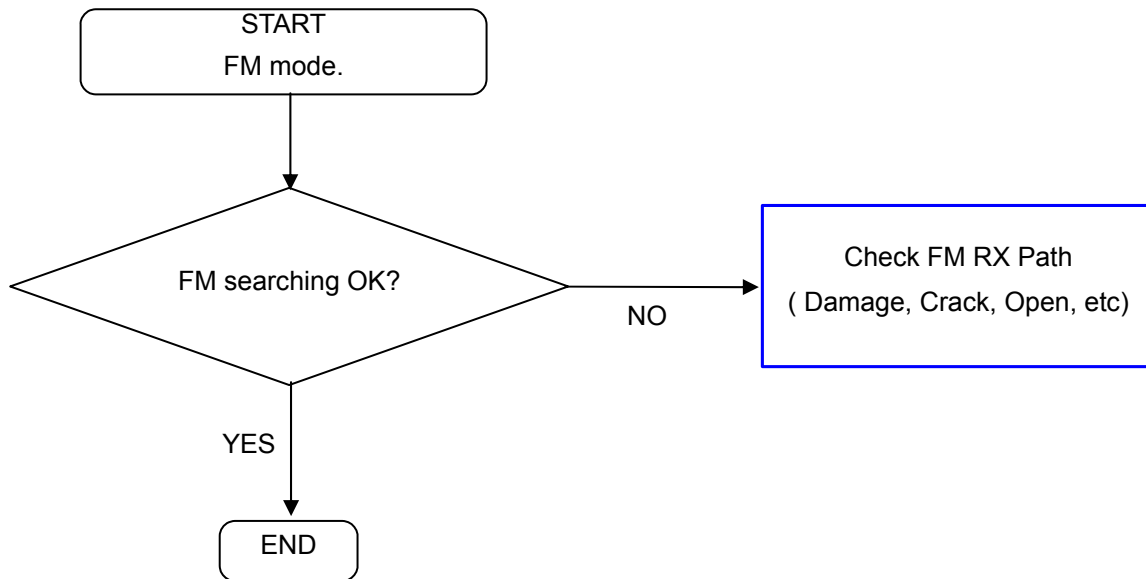

8. Level 3 Repair

8-4-18. RF Section(GPS)

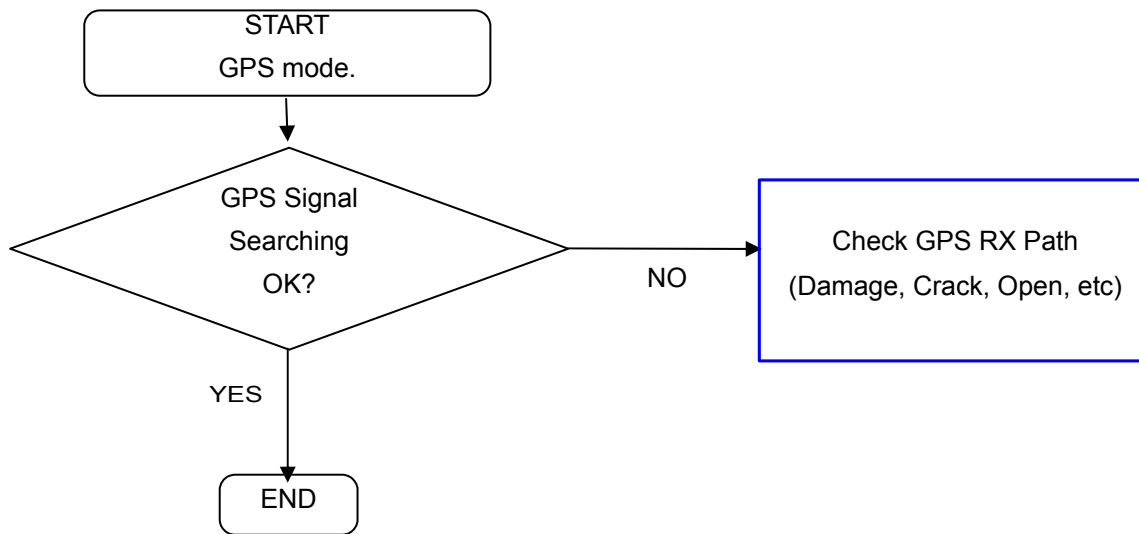

8. Level 3 Repair

8-4-19. RF Section(NFC)

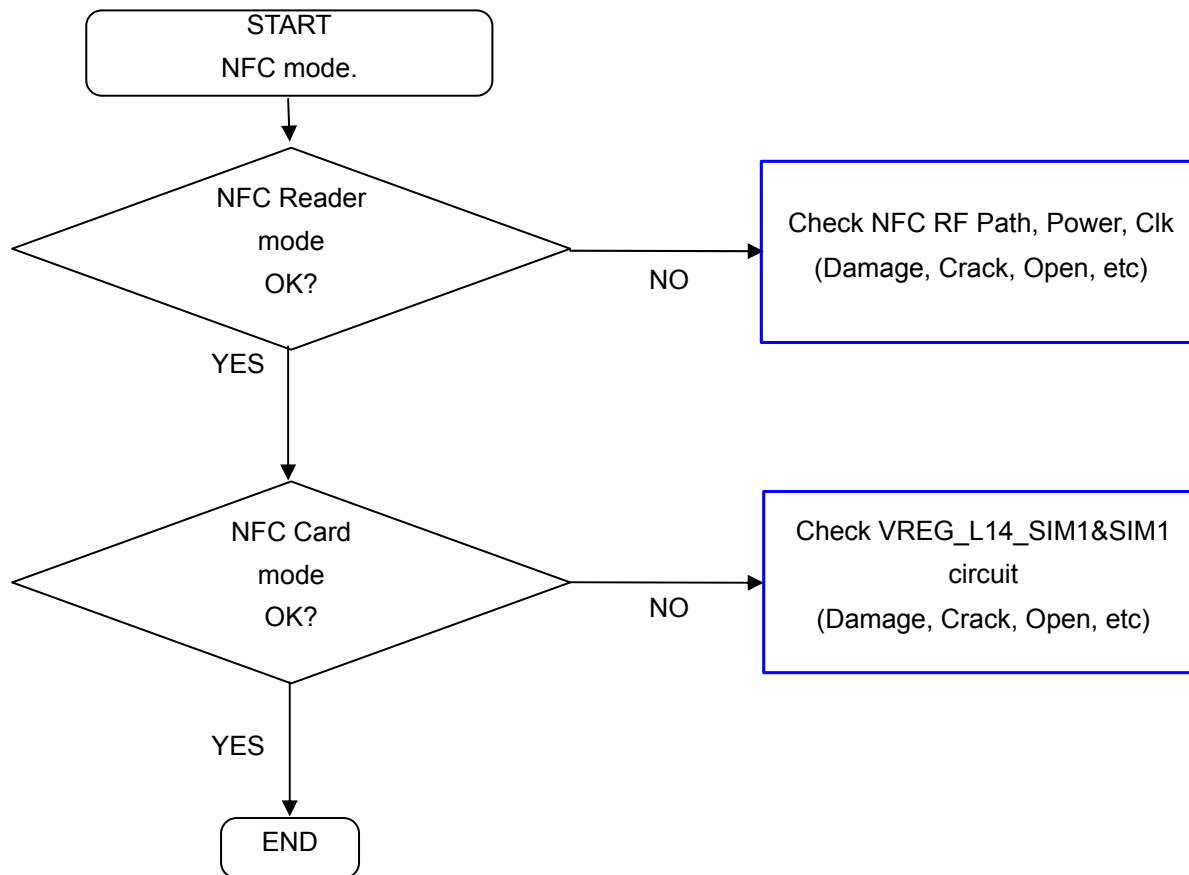

8. Level 3 Repair

8-5. Service Schematics

- NC Point(Top View)

● : NC

UCP3000 (AP)

